



# **PNC380 PoC Radio**

## **User Manual**

# Preface

Welcome to the world of Hytera and thank you for purchasing this product. This manual includes a description of the functions and step-by-step procedures for use. To avoid bodily injury or property loss caused by incorrect operation, please carefully read the *Safety Information Booklet* before use.

This manual is applicable to the following product:

PNC380 PoC Radio

## Copyright Information

Hytera is the trademark or registered trademark of Hytera Communications Corporation Limited (the Company) in the People's Republic of China (PRC) and/or other countries or areas. The Company retains the ownership of its trademarks and product names. All other trademarks and/or product names that may be used in this manual are properties of their respective owners.

The product described in this manual may include the Company's computer programs stored in memory or other media. Laws in PRC and/or other countries or areas protect the exclusive rights of the Company with respect to its computer programs. The purchase of this product shall not be deemed to grant, either directly or by implication, any rights to the purchaser regarding the Company's computer programs. The Company's computer programs may not be copied, modified, distributed, decompiled, or reverse-engineered in any manner without the prior written consent of the Company.

## Disclaimer

The Company endeavors to achieve the accuracy and completeness of this manual, but no warranty of accuracy or reliability is given. All the specifications and designs are subject to change without notice due to continuous technological development. No part of this manual may be copied, modified, translated, or distributed in any manner without the prior written consent of the Company.

We do not guarantee, for any particular purpose, the accuracy, validity, timeliness, legitimacy or completeness of the third-party products and contents involved in this manual.

If you have any suggestions or would like to receive more information, please visit our website at <http://www.hytera.com>.

# Contents

<b>Documentation Information .....</b>	<b>1</b>
<b>1. Before Use .....</b>	<b>3</b>
1.1 Packing List .....	3
1.2 Product Layout .....	4
1.3 (Optional) Installing the SIM Card and Micro SD Card .....	4
1.4 Attaching the Battery .....	5
1.5 Attaching the Belt Clip .....	6
1.6 Attaching the Audio Accessory .....	6
1.7 Charging the Battery .....	7
<b>2. Basic Operations.....</b>	<b>8</b>
2.1 Turning On or Off the Radio .....	8
2.2 Restarting the Radio.....	8
2.3 Adjusting the Volume .....	8
2.4 Understanding the Screen.....	8
2.4.1 Status Indication.....	8
2.4.2 Screen Operations .....	10
2.5 Turning On or Off the Flashlight.....	10
2.6 Setting the Programmable Key .....	10
2.7 Switching the Input Method.....	11
2.8 Checking the Radio Information.....	11
<b>3. PoC Service .....</b>	<b>12</b>
<b>4. Phone Call (PNC380 Pro Only) .....</b>	<b>13</b>
4.1 Initiating a Phone Call .....	13
4.2 Receiving a Phone Call.....	14
<b>5. Messages (PNC380 Pro Only).....</b>	<b>15</b>
5.1 Sending a Message.....	15
5.2 Replying a Message.....	16
5.3 Forwarding or Deleting a Message .....	16
<b>6. Contacts (PNC380 Pro Only).....</b>	<b>18</b>
6.1 Creating a Contact.....	18
6.2 Editing or Deleting a Contact.....	19
<b>7. Network and Data Sharing .....</b>	<b>20</b>
7.1 Mobile Network.....	20
7.1.1 Checking the Data Usage .....	20
7.1.2 Enabling or Disabling the Data Roaming.....	20
7.1.3 Selecting the Network Type .....	20
7.2 WLAN .....	20



7.3 BT .....	21
7.3.1 Pairing with a BT Device .....	21
7.3.2 Disconnecting with a BT Device .....	21
7.3.3 Enabling or Disabling the BT Positioning Feature .....	21
7.3.4 Modifying the BT Device Name .....	22
7.4 Hotspot .....	22
7.4.1 Enabling or Disabling the WLAN Hotspot .....	22
7.4.2 Setting up the Hotspot.....	22
7.5 Airplane Mode .....	23
7.6 NFC (PNC380 Pro Only) .....	23
7.7 USB .....	23
<b>8. Settings .....</b>	<b>24</b>
8.1 Radio Settings .....	24
8.1.1 Display.....	24
8.1.2 Sound .....	25
8.1.3 Storage .....	25
8.1.4 Battery .....	26
8.2 System Settings.....	27
8.2.1 Location.....	27
8.2.2 Languages.....	27
8.2.3 Factory Data Reset .....	28
8.2.4 Date and Time .....	28
8.2.5 Upgrade.....	30
<b>9. Camera (PNC380 Pro Only) .....</b>	<b>31</b>
9.1 Taking a Photo .....	31
9.2 Recording a Video .....	31
9.3 Viewing a Picture or Video .....	31
<b>10. Gallery (PNC380 Pro Only) .....</b>	<b>32</b>
10.1 Photos.....	32
10.1.1 Viewing a Photo .....	32
10.1.2 Managing a Photo .....	32
10.2 Videos.....	32
10.2.1 Playing a Video .....	32
10.2.2 Managing a Video .....	33
<b>11. Sound Recorder .....</b>	<b>34</b>
11.1 Recording an Audio File .....	34
11.2 Playing an Audio File.....	34
11.3 Managing an Audio File.....	34
<b>12. Applications.....</b>	<b>35</b>

---

12.1 Installing an Application.....	35
12.2 Uninstalling an Application .....	35
12.3 Forcibly Stopping an Application.....	35
12.4 Clearing the Data or Cache.....	35
12.5 Setting the Access Permissions.....	36
<b>13. Troubleshooting.....</b>	<b>37</b>
<b>14. Care and Cleaning.....</b>	<b>39</b>
14.1 Product Care .....	39
14.2 Product Cleaning.....	39
<b>15. Optional Accessories .....</b>	<b>40</b>
<b>16. Abbreviations .....</b>	<b>41</b>

# Documentation Information

## Instruction Conventions

Icon	Description
 <b>NOTE</b>	Indicates references that can further describe the related topics.
 <b>CAUTION</b>	Indicates situations that could cause data loss or equipment damage.

## Notation Conventions

Item	Description	Example
<b>Boldface</b>	Denotes menus, tabs, parameter names, window names, dialogue names, and hardware buttons.	To save the configuration, click <b>Apply</b> .
		The <b>Log Level Settings dialogue</b> appears.
		Press the <b>PTT</b> key.
" "	Denotes messages, directories, file names, folder names, and parameter values.	The screen displays "Invalid Battery!"
		Open "PDT_PSS.exe".
		Go to "D:/opt/local".
>	Directs you to access a multi-level menu.	In the <b>Port</b> text box, enter "22".
		Go to <b>File &gt; New</b> .
<i>Italic</i>	Denotes document titles.	For details about using the DWS, refer to <i>Dispatch Workstation User Guide</i> .
Courier New	Denotes commands and their execution results.	To set the IP address, run the following command: <code>vos-cmd - m name IP</code>

## Key Operations

Operation	Description
Short press	Press and release quickly.
Long press	Press and hold for preset time.
Press and hold	Keep the key pressed.



# 1. Before Use

## 1.1 Packing List

Please unpack carefully and check that you have received the following items. If any item is missing or damaged, contact your dealer.

Item	Quantity (PCS)	Item	Quantity (PCS)
Radio	1	Data Cable	1
Battery	1	Battery Cover	1
Power Adapter	1	Strap	1
Belt Clip	1	Documentation Kit	1

---

### NOTE

- Figures in this manual are only for reference.
  - Check the main unit label inside the battery compartment to ensure that the purchased product is correct.
-

## 1.2 Product Layout



## 1.3 (Optional) Installing the SIM Card and Micro SD Card

1. Unlock the battery latch, and then remove the battery cover.

### NOTE

The battery cover is tightly fastened to ensure optimum waterproof performance. It is recommended to remove the battery cover with tools.

2. Open the card slot covers.
3. Install the SIM card and Micro SD card.
4. Put the card slot covers back in place.

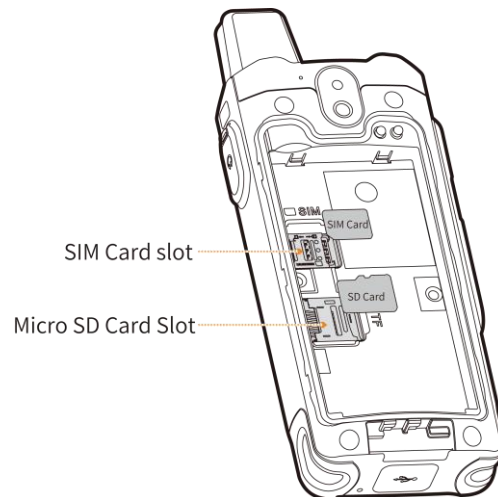

## 1.4 Attaching the Battery

### CAUTION

- Use the approved battery to avoid the risk of explosion.
- Dispose of the used battery according to "Precautions for Disposal" in the *Safety Information Booklet*.

1. Insert the battery into the battery slot.
2. Press the battery cover into place.
3. Slide the battery latch to the lock position.

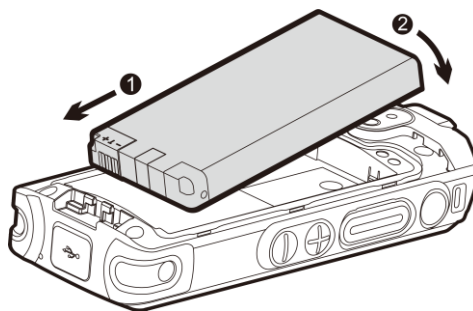

## 1.5 Attaching the Belt Clip

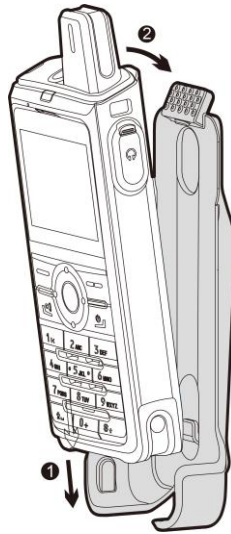

## 1.6 Attaching the Audio Accessory

Open the cover of the audio accessory connector, and then insert the audio accessory into the connector.

### NOTE

To ensure optimum waterproof and dustproof performance, close the cover after removing the audio accessory.

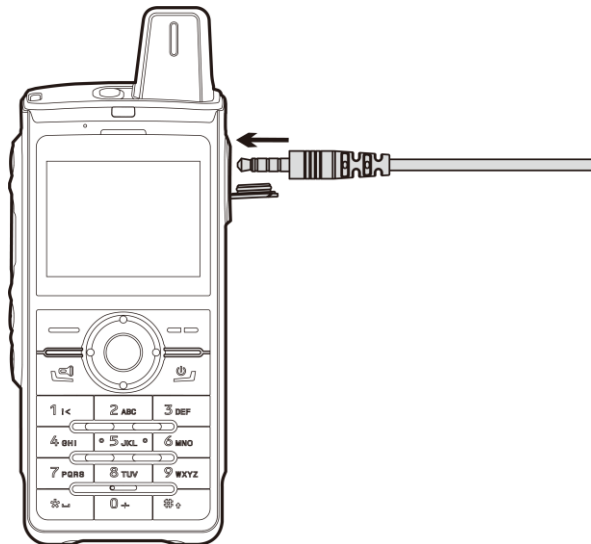

---

## 1.7 Charging the Battery

---

### CAUTION

- Use the approved charger to charge the battery.
- Read the *Safety Information Booklet* before charging.
- The remaining lithium-ion battery power is limited to 30% pursuant to the new lithium battery shipment regulation approved by International Air Transport Association (IATA).

---

To charge the battery, connect the radio to the USB port on the power adapter, mobile power supply, or PC with the data cable.

During charging, check the charging status by the battery level icon or battery percentage shown on the LCD display.

---

### NOTE

To ensure optimum waterproof and dustproof performance, close the USB port cover after charging the radio.

---



## 2. Basic Operations

### 2.1 Turning On or Off the Radio

To turn on the radio, long press  for two seconds.

To turn off the radio, long press  for two seconds, and then select **Power off**.

### 2.2 Restarting the Radio

- Long press  for two seconds, and then select **Reboot**.
- Long press  until the radio restarts.

### 2.3 Adjusting the Volume







To increase the volume, press the **Volume +** key.













To decrease the volume, press the **Volume –** key.

### 2.4 Understanding the Screen

#### 2.4.1 Status Indication

##### LCD Icons

Icon	Radio Status
	The battery is fully charged.
	The battery is low.
	The Battery Saver mode is enabled.
	The battery is being charged.
	The battery is abnormal.
	No SIM card is installed.

Icon	Radio Status
<b>E/3G/4G</b>	The 2G/3G/4G cellular network is enabled.
	The radio has registered with the mobile network.
	The radio has not registered with the mobile network.
	The radio is connected to the WLAN network.
	The WLAN hotspot is enabled.
	The radio operates in Airplane mode.
	An earpiece is connected.
	The radio operates in silent mode.
<b>B</b>	The BT feature is enabled.
<b>·B·</b>	A BT device is connected.
	The GPS is positioning.
	The Near Field Communication (NFC) feature is enabled (PNC380 Pro only).
	The memory is out of space.
	There is/are new message(s).
	There is/are missed call(s).

## LED Indications

LED Indicator	Radio Status
Glows green	<ul style="list-style-type: none"> <li>● The radio is receiving.</li> <li>● There is/are unread message(s) or missed call(s).</li> </ul>
Glows red	The radio is transmitting.
Glows orange	<ul style="list-style-type: none"> <li>● Ready to press the <b>PTT</b> key to speak to an individual.</li> <li>● A dynamic group call is in progress.</li> </ul>

## 2.4.2 Screen Operations

### Turning On or Off the Screen

- To turn off the screen, press **SK**.
- To turn on the screen, press any key on the keypad.

### Locking or Unlocking the Screen

When the screen is not in use, you can lock it to avoid unintended operations, protect privacy, and increase battery life.

- To lock the screen, press **SK**.  
If the standby time reaches the sleep time, the screen is automatically locked.
- To unlock the screen, press any key on the keypad.

### Setting the Lock Pattern

1. Press the **Navigation** key to select , and then press the **OK/Menu** key.
2. Press the **Navigation** key to select **Screen lock**, and then press the **OK/Menu** key.
3. Press the **Navigation** key to select **None**, **Keypad**, or **Password**, and then press the **OK/Menu** key.

With the lock pattern enabled, press any key, press the **Option** key, or enter the password to unlock the screen.

## 2.5 Turning On or Off the Flashlight

Long press .

## 2.6 Setting the Programmable Key





The radio provides **SK** as the programmable key. When you assign a specific feature to the key, you can short press or long press this key to quickly activate the feature.

1. Press the **Navigation** key to select , and then press the **OK/Menu** key.
2. Press the **Navigation** key to select **Programmable key**, and then press the **OK/Menu** key.
3. Press the **Navigation** key to select **Short press** or **Long press**, and then press the **OK/Menu** key.
4. Select the feature.



## 2.7 Switching the Input Method

You can input symbols, numbers, characters, or letters through the keypad.

- Press  to switch the input method.
- In number mode, press  to enter "1". In other modes, press  to input special characters.
- Press  to enter "\*". Long press  to input a blank space.

## 2.8 Checking the Radio Information

You can check the radio information such as status, model, and version.

1. Press the **Navigation** key to select , and then press the **OK/Menu** key.
2. Press the **Navigation** key to select **About phone**, and then press the **OK/Menu** key.

## 3. PoC Service

The Push-to-Talk over Cellular (PoC) service provides one-to-one and one-to-many voice communications over the wider-coverage public network.



### NOTE

This service is available only when you have installed the PoC application on the radio.

---

After the radio is connected to a WLAN or cellular network, you can initiate a call through the PoC application.

1. Press the **Navigation** key to select the PoC application, and then press the **OK/Menu** key.
2. Do either of the following:
  - Select a contact from the contact list or recent call list.
  - Enter a contact number in the dialpad.
3. Press the **Option** key to select a call type, and then press the **OK/Menu** key.
4. Speak into the microphone.
  - For a half-duplex voice call, press and hold the **PTT** key to speak, and release the **PTT** key after finishing speaking.
  - For a full-duplex voice call, speak directly without pressing the **PTT** key.

If you set the standby group, you can initiate a call to the group directly.

1. Press the **Navigation** key to select the PoC application, and then press the **OK/Menu** key.
2. Press and hold the **PTT** key to speak, and release the **PTT** key after finishing speaking.



### NOTE





For more operations, refer to the *User Manual* of the PoC application.

---





## 4. Phone Call (PNC380 Pro Only)

### 4.1 Initiating a Phone Call





#### Through Manual Dialing

1. Do either of the following:
  - Press the **Navigation** key to select , and then press the **OK/Menu** key.
  - Press  .
2. Press the **Navigation** key to enter the  tab.
3. Enter the phone number.
4. Press  .



#### Through Call Logs

1. Do either of the following:
  - Press the **Navigation** key to select , and then press the **OK/Menu** key.
  - Press  .
2. Press the **Navigation** key to enter the  tab.
3. Press the **Navigation** key to select the call log.
4. Press  .

#### Through Contacts



1. Do either of the following:
  - Press the **Navigation** key to select , and then press the **OK/Menu** key.
  - Press  .
2. Press the **Navigation** key to enter the  tab.
3. Press the **Navigation** key to select the contact.
4. Press  .

## Through Messaging

1. Press the **Navigation** key to select , and then press the **OK/Menu** key.
2. Press the **Navigation** key to select the message.
3. Press  .

## 4.2 Receiving a Phone Call

When you receive a phone call, do either of the following:

- To answer the call, press  .
- To reject the call, press  .

## 5. Messages (PNC380 Pro Only)



You can send text messages.

### 5.1 Sending a Message



#### Through Messaging

1. Press the **Navigation** key to select , and then press the **OK/Menu** key.
2. Press the **OK/Menu** key to create a new message.
3. In the **To** field, do either of the following:
  - Enter the phone number.
  - Add the contact.
    - i. Press the **Option** key, and then press the **Navigation** key to select the contact.
    - ii. Press the **OK/Menu** key, and then press the **Option** key.
4. Press the **Navigation** key to select the **Content** field, and then do either of the following:
  - Enter the message content.
  - Add the quick reply.
    - i. Press the **Option** key, and then press the **Navigation** key to select the quick text.
    - ii. Press the **OK/Menu** key.
5. Press the **OK/Menu** key to send the message.



#### Through Manual Dialing

1. Do either of the following:
  - Press the **Navigation** key to select , and then press the **OK/Menu** key.
  - Press  .
2. Press the **Navigation** key to enter the  tab.
3. Enter the phone number.
4. Press the **OK/Menu** key to enter the new message interface.
5. Enter the message content, and then send the message. For details, see step 4–5 of [Through Messaging](#).

## Through Call Logs

1. Do either of the following:
  - Press the **Navigation** key to select , and then press the **OK/Menu** key.
  - Press  .
2. Press the **Navigation** key to enter the  tab.
3. Press the **Navigation** key to select the call log.
4. Press the **Option** key, select **Send message**, and then press the **OK/Menu** key to enter the new message interface.
5. Enter the message content, and then send the message. For details, see step 4–5 of [Through Messaging](#).

## Through Contacts

1. Do either of the following:
  - Press the **Navigation** key to select , and then press the **OK/Menu** key.
  - Press  .
2. Press the **Navigation** key to enter the  tab.
3. Press the **Navigation** key to select the contact.
4. Press the **Option** key, select **Send message**, and then press the **OK/Menu** key to enter the new message interface.
5. Enter the message content, and then send the message. For details, see step 4–5 of [Through Messaging](#).

## 5.2 Replying a Message

1. Press the **Navigation** key to select , and then press the **OK/Menu** key.
2. Press the **Navigation** key to select the message.
3. Press the **OK/Menu** key twice to reply the message.

## 5.3 Forwarding or Deleting a Message



1. Press the **Navigation** key to select , and then press the **OK/Menu** key.

2. Press the **Navigation** key to select the message.
3. Press the **OK/Menu** key to enter the message interface.
4. Press the **Navigation** key to select the message content.
5. Press the **Option** key, and then do either of the following:
  - To forward the message, press the **OK/Menu** key.
  - To delete the message, press the **Navigation** key to select **Delete**, and then press the **OK/Menu** key.



## 6. Contacts (PNC380 Pro Only)

### 6.1 Creating a Contact



#### Through Manual Dialing

1. Do either of the following:
  - Press the **Navigation** key to select , and then press the **OK/Menu** key.
  - Press  .
2. Press the **Navigation** key to enter the  tab, and then enter the phone number.
3. Press the **Option** key, and then press the **OK/Menu** key.
4. Enter the contact name.
5. Press the **Option** key to save the contact.

#### Through Call Logs

1. Do either of the following:
  - Press the **Navigation** key to select , and then press the **OK/Menu** key.
  - Press  .
2. Press the **Navigation** key to enter the  tab.
3. Press the **Navigation** key to select the call log.
4. Press the **Option** key, and then press the **Navigation** key to select **Create contact**.
5. Press the **OK/Menu** key.
6. Enter the contact name.
7. Press the **Option** key to save the contact.

#### Through Contacts

1. Do either of the following:
  - Press the **Navigation** key to select , and then press the **OK/Menu** key.
  - Press  .





2. Press the **Navigation** key to enter the  tab.
3. Press the **OK/Menu** key.
4. Enter the contact name and phone number.
5. Press the **Option** key to save the contact.

## Through Messaging

1. Press the **Navigation** key to select , and then press the **OK/Menu** key.
2. Press the **Navigation** key to select the message.
3. Press the **Option** key, and then press the **Navigation** key to select **New contact**.
4. Press the **OK/Menu** key.
5. Enter the contact name, and then press the **Option** key to save the contact.

## 6.2 Editing or Deleting a Contact

1. Do either of the following:
  - Press the **Navigation** key to select , and then press the **OK/Menu** key.
  - Press  .
2. Press the **Navigation** key to enter the  tab.
3. Press the **Navigation** key to select the contact.
4. Press the **Option** key, and then do either of the following:
  - To edit the contact, press the **Navigation** key to select **Edit contact**, and then press the **OK/Menu** key.
  - To delete the contact, press the **Navigation** key to select **Delete contact**, and then press the **OK/Menu** key.

## 7. Network and Data Sharing

### 7.1 Mobile Network

Before connecting to the mobile network, make sure that the SIM card is installed and the mobile data service is activated.

#### 7.1.1 Checking the Data Usage

You can view the amount of data usage to avoid exceeding the data usage limit.

1. Press the **Navigation** key to select , and then press the **OK/Menu** key.
2. Press the **Navigation** key to select **Data usage**, and then press the **OK/Menu** key.
3. Press the **Navigation** key to select **Cellular data usage**, and then press the **OK/Menu** key.

#### 7.1.2 Enabling or Disabling the Data Roaming

You can access data services when you are outside the service area of your network provider.

1. Go to **Data usage**. For details, see step 1–2 in [7.1.1 Checking the Data Usage](#).
2. Press the **Navigation** key to select **Mobile network settings**, and then press the **OK/Menu** key.
3. Press the **OK/Menu** key to enable or disable **Data roaming**.

#### 7.1.3 Selecting the Network Type

1. Go to **Data usage**. For details, see step 1–2 in [7.1.1 Checking the Data Usage](#).
2. Press the **Navigation** key to select **Mobile network settings**, and then press the **OK/Menu** key.
3. Press the **Navigation** key to select **Preferred network type**, and then select the network.

### 7.2 WLAN

After successful WLAN connection, you can visit the Internet or shared media from other devices in the network.

To connect the radio to the WLAN network, do as follows:

1. Press the **Navigation** key to select , and then press the **OK/Menu** key.

2. Press the **OK/Menu** key to enter the WLAN interface.
3. Press the **OK/Menu** key to enable **WLAN**.
4. Press the **Navigation** key to select an available network from the WLAN list.
5. Press the **OK/Menu** key.

If a password is required, enter the password, press the **Navigation** key to select **Connect**, and then press the **OK/Menu** key.

The radio saves WLAN information upon successful connection.

## 7.3 BT

The BT feature allows you to transmit voice through wireless earpiece or wireless ring PTT.



### NOTE

The PNC380 Pro supports short-distance pictures, audio files, and videos sharing through the BT.

---

### 7.3.1 Pairing with a BT Device

1. Press the **Navigation** key to select , and then press the **OK/Menu** key.
2. Press the **Navigation** key to select **BT**, and then press the **OK/Menu** key.
3. Press the **OK/Menu** key to enable **BT**.
4. Press the **Navigation** key to select the device from the **Available devices** list.
5. Press the **OK/Menu** key.

### 7.3.2 Disconnecting with a BT Device

1. Go to  > **BT** > **Paired devices**. For details, see step 1–2 in [7.3.1 Pairing with a BT Device](#).
2. Press the **Navigation** key to select the device.
3. Press the **OK/Menu** key to disconnect with the device.

### 7.3.3 Enabling or Disabling the BT Positioning Feature

With BT beacons, the BT Positioning feature can be developed on the basis of the public network and back-end

system to improve the accuracy of indoor positioning. This feature is suited for position tracking and navigation in the indoor or semi-enclosed areas.

To enable or disable the feature, do as follows:

1. Press the **Navigation** key to select , and then press the **OK/Menu** key.
2. Press the **Navigation** key to select **BT**, and then press the **OK/Menu** key.
3. Press the **Navigation** key to select **BT location**, and then press the **OK/Menu** key.

With the BT Positioning feature enabled, the radio searches the beacons and reports the beacon data once or periodically.

### 7.3.4 Modifying the BT Device Name

1. Go to  > **BT**. For details, see step 1–2 in [7.3.1 Pairing with a BT Device](#).
2. Press the **Navigation** key to select **Device name**, and then press the **OK/Menu** key.
3. Enter the device name.
4. Press the **Navigation** key to select **OK**, and then press the **OK/Menu** key.

## 7.4 Hotspot

After connecting the radio to the mobile network, you can create a hotspot to offer internet connection to other devices.

### 7.4.1 Enabling or Disabling the WLAN Hotspot

1. Press the **Navigation** key to select , and then press the **OK/Menu** key.
2. Press the **Navigation** key to select **More**, and then press the **OK/Menu** key.
3. Press the **Navigation** key to select **Tethering & portable hotspot**, and then press the **OK/Menu** key.
4. Press the **OK/Menu** key to enable or disable **Portable WLAN hotspot**.

### 7.4.2 Setting up the Hotspot

1. Go to **Tethering & portable hotspot**. For details, see step 1–3 in [7.4.1 Enabling or Disabling the WLAN Hotspot](#).

2. Specify **Network name**, **Security**, **Password**, and **Frequency band**.

## 7.5 Airplane Mode

When you are in an airplane or in an area with radio restrictions, you may be required to turn off your radio or make your radio enter the airplane mode. In airplane mode, your radio automatically disables the mobile network and WLAN. In this case, you cannot use voice or data services.

To enable or disable Airplane mode, do as follows:

1. Press the **Navigation** key to select , and then press the **OK/Menu** key.
2. Press the **Navigation** key to select **More**, and then press the **OK/Menu** key.
3. Press the **OK/Menu** key to enable or disable **Airplane mode**.

## 7.6 NFC (PNC380 Pro Only)

The Near Field Communication (NFC) is a wireless connection technology that offers easy, secure and fast communication. This feature allows the radio to recognize nearby NFC-capable devices for data exchange without connecting to a network.

To enable or disable the NFC feature, do as follows:

1. Press the **Navigation** key to select , and then press the **OK/Menu** key.
2. Press the **Navigation** key to select **More**, and then press the **OK/Menu** key.
3. Press the **Navigation** key to select **NFC**, and then press the **OK/Menu** key to enable or disable **NFC**.

## 7.7 USB

The radio can be connected to the computer through a USB cable for charging or data transmission.

- **Only charge this device:** The radio will only be charged.
- **Transfer files:** The radio can transfer files with the computer.
- **Transfer photos:** The radio can transfer photos with the computer.

## 8. Settings

### 8.1 Radio Settings

#### 8.1.1 Display

##### Adjusting the Brightness

You can adjust the brightness to make the screen brighter or dimmer in different situations.

1. Press the **Navigation** key to select , and then press the **OK/Menu** key.
2. Press the **Navigation** key to select **Display**, and then press the **OK/Menu** key.
3. Press the **OK/Menu** key.
4. Press the **Navigation** key left or right.

##### Setting the Sleep Time

You can set the sleep time to allow the radio to automatically turn off its screen if no operation is made within the preset sleep time. It helps save battery power.

1. Press the **Navigation** key to select , and then press the **OK/Menu** key.
2. Press the **Navigation** key to select **Display**, and then press the **OK/Menu** key.
3. Press the **Navigation** key to select **Sleep**, and then press the **OK/Menu** key.
4. Press the **Navigation** key to select the sleep time, and then press the **OK/Menu** key.

##### Adjusting the Font Size

You can adjust the font size according to your reading habit.

1. Press the **Navigation** key to select , and then press the **OK/Menu** key.
2. Press the **Navigation** key to select **Display**, and then press the **OK/Menu** key.
3. Press the **Navigation** key to select **Font size**, and then press the **OK/Menu** key.
4. Press the **Navigation** key to select **Default** or **Large**, and then press the **OK/Menu** key.

## 8.1.2 Sound

### Setting the Profile

You can set the profile of the radio according to different scenarios.

1. Press the **Navigation** key to select , and then press the **OK/Menu** key.
2. Press the **Navigation** key to select **Sound**, and then press the **OK/Menu** key.
3. Press the **OK/Menu** key.
4. Press the **Navigation** key to select **Silent** or **Ringtone**, and then press the **OK/Menu** key.

### Adjusting the Media Volume

1. Press the **Navigation** key to select , and then press the **OK/Menu** key.
2. Press the **Navigation** key to select **Sound**, and then press the **OK/Menu** key.
3. Press the **Navigation** key to select **Volumes**, and then press the **Navigation** key left or right.

### Customizing the Alert Sound (PNC380 Pro Only)

1. Press the **Navigation** key to select , and then press the **OK/Menu** key.
2. Press the **Navigation** key to select **Sound**, and then press the **OK/Menu** key.
3. Press the **Navigation** key to select **Phone ringtone** or **Default notification ringtone**, and then press the **OK/Menu** key.
4. Press the **Navigation** key to select the ringtone, and then press the **OK/Menu** key.
5. Press the **Navigation** key to select **OK**, and then press the **OK/Menu** key.

## 8.1.3 Storage

### Viewing the Storage Usage

1. Press the **Navigation** key to select , and then press the **OK/Menu** key.
2. Press the **Navigation** key to select **Storage**, and then press the **OK/Menu** key.

## Freeing up the Storage Space

1. Press the **Navigation** key to select , and then press the **OK/Menu** key.
2. Press the **Navigation** key to select **Storage**, and then press the **OK/Menu** key.
3. Press the **OK/Menu** key to view the internal storage.
4. Press the **Navigation** key to select **Cached data**, and then press the **OK/Menu** key.  
The **Clear cached data?** dialog box appears.
5. Press the **OK/Menu** key.

## 8.1.4 Battery

### Viewing the Battery Power

You can view the proportion of remaining battery power and the power usage of applications.

1. Press the **Navigation** key to select , and then press the **OK/Menu** key.
2. Press the **Navigation** key to select **Battery**, and then press the **OK/Menu** key.  
The remaining battery power is shown.
3. Press the **Navigation** key to select **Battery usage**, and then press the **OK/Menu** key.  
The power usage of applications is shown.

### Enabling the Battery Saver Mode

1. Press the **Navigation** key to select , and then press the **OK/Menu** key.
2. Press the **Navigation** key to select **Battery**, and then press the **OK/Menu** key.
3. Do either of the following:
  - To enable or disable Battery Saver mode manually, press the **Navigation** key to select **Battery saver**, and then press the **OK/Menu** key.
  - To allow the radio to enable Battery Saver mode automatically, press the **Navigation** key to select **Power saving mode is on**, press the **OK/Menu** key, and then select the criterion to trigger Battery Saver mode.



## 8.2 System Settings

### 8.2.1 Location

The Location feature allows the radio to obtain its location information through WLAN, mobile network, BT, or GPS.

The location-related apps, such as Camera and Hytalk can access the location data of the radio.

#### Setting the Location Mode

1. Press the **Navigation** key to select , and then press the **OK/Menu** key.
2. Press the **Navigation** key to select **Location**, and then press the **OK/Menu** key.
3. Press the **OK/Menu** key to enable **Location**.
4. Press the **Navigation** key to select **Mode**, and then press the **OK/Menu** key.
5. Select one of the following location modes:
  - **High accuracy**: The radio locates accurately through GPS, WLAN, and mobile network.
  - **Battery saving**: The radio locates only through WLAN, and mobile network, so as to save battery power.
  - **Device only**: The radio locates only through GPS without using data traffic.

#### Setting the Scanning Mode

1. Enable **Location**. For details, see [Setting the Location Mode](#).
2. Press the **Navigation** key to select **Scanning**, and then press the **OK/Menu** key.
3. Select whether to enable the following scanning modes:
  - **WLAN scanning**: Improve location by allowing system apps and service to detect WLAN networks at any time.
  - **BT scanning**: Improve location by allowing system apps and service to detect Bluetooth devices at any time.

### 8.2.2 Languages

1. Press the **Navigation** key to select , and then press the **OK/Menu** key.

2. Press the **Navigation** key to select **Languages**, and then press the **OK/Menu** key.
3. Press the **Navigation** key to select the display language, and then press the **OK/Menu** key.

## 8.2.3 Factory Data Reset

### CAUTION

The Factory Data Reset feature will erase all information on the radio such as personal information and downloaded apps.

When the radio runs slowly or the apps quit unexpectedly, you can reset the radio to the factory settings to fix the problem.

1. Press the **Navigation** key to select , and then press the **OK/Menu** key.
2. Press the **Navigation** key to select **Factory data reset**, and then press the **OK/Menu** key three times.

## 8.2.4 Date and Time

The radio can automatically synchronize with the local date, time, and time zone over a mobile network or allows you to manually set them.

### Setting the Date, Time, and Time Zone

1. Press the **Navigation** key to select , and then press the **OK/Menu** key.
2. Press the **Navigation** key to select **Date & time**, and then press the **OK/Menu** key.
3. Press the **Navigation** key to select **Automatic date & time** or **Automatic time zone**, and then do one of the following:

Method	Operation
Enable the radio to update the date, time, and time zone automatically	Press the <b>OK/Menu</b> key to enable the option.
Set the date, time, and time zone manually	<ol style="list-style-type: none"> <li>1. Press the <b>OK/Menu</b> key to disable the option.</li> <li>2. Press the <b>Navigation</b> key to select <b>Set date</b>, <b>Set time</b>, or <b>Select time zone</b>, and then press the <b>OK/Menu</b> key.</li> <li>3. Specify the date, time, or time zone.</li> </ol>

## Setting the Time Format

You can set the time format to 12-hour or 24-hour.

1. Press the **Navigation** key to select , and then press the **OK/Menu** key.
2. Press the **Navigation** key to select **Date & time**, and then press the **OK/Menu** key.
3. Press the **Navigation** key to select **Use 24-hour format**, and then press the **OK/Menu** key to enable the feature.

The radio uses the 24-hour format. Otherwise, the radio uses the 12-hour format.

## 8.2.5 Upgrade

---

### CAUTION

- During the upgrade, do not power off the radio. Otherwise, the radio may be not used.
  - Be sure to back up your data before upgrade.
  - Ensure that the battery power is more than 30% before upgrading.
- 

When an update is available, you can upgrade the system in one of the following ways:

- In Auto-Upgrade mode, you can download the firmware package from the MDM server through the wireless network to upgrade the system
  - a. Press the **Navigation** key to select , and then press the **OK/Menu** key.
  - b. Press the **Navigation** key to select **System upgrade**, and then press the **OK/Menu** key.
  - c. Follow the on-screen instructions to download and install the upgrade package.
- In Enforced Management mode, the radio is forced to communicate with the MDM server in real time and receive firmware updates from the server.
  - The radio upgrades the system automatically.
  - When receiving the upgrade notification from the MDM server, select **Upgrade now**. The radio starts to download and install the latest upgrade package.



## 9. Camera (PNC380 Pro Only)

The Camera application allows you to shoot photos and videos.



### 9.1 Taking a Photo

1. Press the **Navigation** key to select , and then press the **OK/Menu** key.
2. (Optional) Press the **Option** key to select **Settings** to set the **Resolution** and **Flash**.
3. Press the **OK/Menu** key to take the photo.

### 9.2 Recording a Video

1. Press the **Navigation** key to select , and then press the **OK/Menu** key.
2. Press the **Navigation** key to enter the  tab.
3. Press the **OK/Menu** key to start recording video.
4. (Optional) Press the **Option** key to select **Settings**, and then set the **Resolution** and **Flash**.
5. Press the **OK/Menu** key again to finish recording.

### 9.3 Viewing a Picture or Video

1. Press the **Navigation** key to select , and then press the **OK/Menu** key.
2. Press the **Navigation** key to enter the  tab.
3. Press the **Option** key to view pictures or videos in the gallery.

## 10. Gallery (PNC380 Pro Only)

The Gallery application allows you to manage pictures and videos.

### 10.1 Photos

#### 10.1.1 Viewing a Photo

1. Press the **Navigation** key to select , and then press the **OK/Menu** key.
2. Press the **OK/Menu** key to enter the photos interface.
3. Press the **Navigation** key to select the photo, and then press the **OK/Menu** key to view the photo.
4. Press the **OK/Menu** key again to zoom out the photo.

#### 10.1.2 Managing a Photo

1. Open the photo. For details, see step 1–3 in [10.1.1 Viewing a Photo](#).
2. Press the **Option** key, and then do one of the following:
  - Press the **OK/Menu** key to move the audio file to SD card if a SD card is installed.
  - Press the **Navigation** key to select **Share via BT**, and then press the **OK/Menu** key to share the photo through the BT if a BT device is connected.
  - Press the **Navigation** key to select **View details**, and then press the **OK/Menu** key to view the photo details, such as type, time, resolution, file size, and storage path.
  - Press the **Navigation** key to select **Delete**, and then press the **OK/Menu** key to delete the photo.

### 10.2 Videos

#### 10.2.1 Playing a Video

1. Press the **Navigation** key to select , and then press the **OK/Menu** key.
2. Press the **Navigation** key to select **Videos**, and then press the **OK/Menu** key.
3. Press the **Navigation** key to select the video, and then press the **OK/Menu** key to open the video.

4. Press the **OK/Menu** key again to play the video.
5. (Optional) Press the **Navigation** key left or right to rewind or fast-forward the video.

## 10.2.2 Managing a Video

1. Open the video. For details, see step 1–3 in [10.2.1 Playing a Video](#).
2. Press the **Option** key, and then do one of the following:
  - Press the **OK/Menu** key to move the video to SD card if a SD card is installed.
  - Press the **Navigation** key to select **Share via BT**, and then press the **OK/Menu** key to share the video through the BT if a BT device is connected.
  - Press the **Navigation** key to select **View details**, and then press the **OK/Menu** key to view the video details, such as type, recording time, duration, resolution, file size, and storage path.
  - Press the **Navigation** key to select **Delete**, and then press the **OK/Menu** key to delete the video.

# 11. Sound Recorder

The SoundRecorder application allows you to record voice at any time during your work time or daily life.

## 11.1 Recording an Audio File

1. Press the **Navigation** key to select , and then press the **OK/Menu** key.
2. Press the **OK/Menu** key to start recording.
3. Press the **OK/Menu** key again to finish recording.

## 11.2 Playing an Audio File

1. Press the **Navigation** key to select , and then press the **OK/Menu** key.
2. Press **OK/Menu** key to play the audio.
3. (Optional) Press the **Navigation** key left or right to rewind or fast-forward the audio.

## 11.3 Managing an Audio File

1. Press the **Navigation** key to select , and then press the **OK/Menu** key.
2. Press the **Option** key, and then select the audio file.
3. Press the **Option** key again, and then do one of the following:
  - Press the **OK/Menu** key to move the audio file to SD card if a SD card is installed.
  - Press the **Navigation** key to select **Share via BT**, and then press the **OK/Menu** key to share the audio file through the BT if a BT device is connected.
  - Press the **Navigation** key to select **View details**, and then press the **OK/Menu** key to view the audio details, such as recording time, duration, file size and storage path.
  - Press the **Navigation** key to select **Delete**, and then press the **OK/Menu** key to delete the audio file.



# 12. Applications

## 12.1 Installing an Application

---

### CAUTION

- To protect the device from malware or viruses, download the trusted applications only.
  - To avoid personal information leakage or misuse, read the instruction carefully and operate with caution when installing an application.
- 

You can download and install applications from the MDM after successfully connected and registered with it.

## 12.2 Uninstalling an Application

If you no longer use an app, you can uninstall it to release storage and improve radio performance.

1. Press the **Navigation** key to select , and then press the **OK/Menu** key.
2. Press the **Navigation** key to select **Apps**, and then press the **OK/Menu** key.
3. Press the **Navigation** key to select the application, and then press the **OK/Menu** key.
4. Press the **Navigation** key to select **Uninstall**, and then press the **OK/Menu** key.

## 12.3 Forcedly Stopping an Application

If an application is not responding, you can forcedly stop this application.

1. Enter the application settings interface. For details, see step 1–3 in [12.2 Uninstalling an Application](#).
2. Press the **Navigation** key to select **Force stop**, and then press the **OK/Menu** key.

## 12.4 Clearing the Data or Cache

You can clear the configuration information or temporarily cached data when there is insufficient storage or the application runs slowly.

1. Enter the application settings interface. For details, see step 1–3 in [12.2 Uninstalling an Application](#).
2. Press the **Navigation** key to select **Storage**, and then press the **OK/Menu** key.
3. Do either of the following:

- To clear the data, press the **OK/Menu** key.
- To clear the cache, press the **Navigation** key to select **Clear cache**, and then press the **OK/Menu** key.

## 12.5 Setting the Access Permissions

You can manage the permissions for apps to access privacy features, so as to protect your personal data and avoid information leakage.

1. Enter the application settings interface. For details, see step 1–3 in [12.2 Uninstalling an Application](#).
2. Press the **Navigation** key to select **Permissions**, and then press the **OK/Menu** key.
3. Press the **OK/Menu** key to enable or disable the permissions.

## 13. Troubleshooting

Phenomena	Analysis	Solution
The radio cannot be turned on.	The battery may be installed improperly.	Remove and reattach the battery.
	The battery power may run out.	Recharge or replace the battery.
	The battery may suffer from poor contact caused by dirtied or damaged battery contacts.	Clean the battery contacts.
The radio fails to respond to any operation.	Too many apps are running.	Forcibly stop some apps or restart the radio.
The keys, LCD display, or LED indicator do(es) not work normally.	The keys, LCD display, or LED indicator may fail to function temporarily.	Restart the radio.
	The keys, LCD display, or LED indicator may be damaged.	Contact your dealer or Hytera technicians for maintenance.
The radio fails to be unlocked.	The keys may fail to function temporarily.	Restart the radio.
	The unlock pattern or password may be incorrect.	Contact your dealer or Hytera technicians for maintenance.
The radio cannot access the mobile network.	The SIM card is abnormal or out of service because of unpaid charges.	<ul style="list-style-type: none"> <li>● Make sure SIM card functions properly.</li> <li>● Pay the charges, and then restart the radio.</li> </ul>
	The mobile data feature is not enabled for the SIM card.	Contact the carrier to enable the data connection feature.
	The signal may be weak.	Make sure the radio is within the network coverage.

Phenomena	Analysis	Solution
	Both the mobile and WLAN network are turned on, but the WLAN connection is unstable.	Turn the WLAN off.
You are unable to hear anyone because of too much noise and hiss.	The signal may be weak.	Make sure call participants are within the communication range.
	The radio may be at an unfavorable position. For example, the signal may be blocked by tall buildings or frustrated in the underground areas.	Move to an open and flat area, and try again.
	The radio may suffer from external disturbance (such as electromagnetic interference).	Stay away from equipment that may cause interference.
The radio fails to detect the SIM card or SD card.	The SIM card or SD card may be installed improperly.	Remove and reattach the SIM card or SD card.
	The SIM card or SD card may suffer from poor contact caused by dirtied or damaged metal contacts.	Clean the metal contacts of the SIM card or SD card.
The GPS cannot locate your position.	The radio may be at an unfavorable position. For example, the signal may be blocked by high buildings or frustrated in the underground areas.	Move to an open and flat area, and try again.
The battery fails to be charged.	The data cable may be connected improperly.	Remove and reinsert the data cable.
	The power adapter plug may be inserted into the socket improperly.	Remove and reinsert the plug.

If the above solutions cannot fix your problems, or you may have some other queries, contact your dealer or the Company for more technical support.

## 14. Care and Cleaning

To guarantee optimal performance as well as a long service life of the radio, follow the tips below.

### 14.1 Product Care

- Do not pierce or scrape the radio.
- Do not drop the radio or collide with other objects.
- Keep the radio far away from substances that can corrode the circuitry.
- Do not hold the radio by the earpiece cable.

### 14.2 Product Cleaning

---

#### CAUTION

Turn the radio off and remove the battery before cleaning.

---

- Clean up the dust and fine particles on the radio surface and charging piece with a clean and dry lint-free cloth or a brush regularly.
- Use neutral cleanser and a non-woven fabric to clean the screen, keys, and front case after long-time use. Do not use chemical preparations such as stain removers, alcohol, sprays or oil preparations, so as to avoid surface case damage.
- Make sure the radio is completely dry before use.

## 15. Optional Accessories

---

### CAUTION

Use the accessories specified by the Company only. Otherwise, we will not be liable for any loss or damage arising out of use of any unauthorized accessories.

---

Contact your dealer for the optional accessories used with the radio.

## 16. Abbreviations

Abbreviation	Full Name
G	
GPS	Global Positioning System
L	
LCD	Liquid-Crystal Display
LED	Light-Emitting Diode
M	
MDM	Mobile Device Management
P	
PC	Personal Computer
PoC	PTT Over Cellular
PTT	Push-To-Talk
S	
SD	Secure Digital Memory Card
SIM	Subscriber Identity Module
SK	Side Key
U	
USB	Universal Serial Bus
W	
WLAN	Wireless Local Area Networks



is the trademark or registered trademark of Hytera Communications Corporation Limited.

© 2021 Hytera Communications Corporation Limited. All Rights Reserved.

Address: Hytera Tower, Hi-Tech Industrial Park North, 9108# Beihuan Road, Nanshan District,  
Shenzhen, People's Republic of China

Postcode: 518057

<http://www.hytera.com>